

SVEN®
YOU WANT – WE CAN

Active Two-way Hi-Fi Stereo
System with Digital Control

OPERATION MANUAL



GRAND

www.sven.fi

Congratulations on your purchase of the Sven speaker system!

Please read this operation manual before using the unit and retain this operation manual in a safe place for future reference.

COPYRIGHT

© 2011. SVEN Company Ltd. Version 1.0 (V 1.0).

This manual and information contained in it are copyrighted. All rights reserved.

TRADEMARKS

All trademarks are the property of their legal holders.

NOTICE OF RESPONSIBILITY RESTRICTION

Despite the exerted efforts to make this manual more exact, some discrepancies may occur. The information of this manual is given on «as is» terms. The author and the publisher do not bear any liability to a person or an organization for loss or damages which have arisen from the information, contained in the given manual.

UNPACKING

Unpack the device carefully. Make sure there are no accessories left in the box. Check up the device for damages; if the product was damaged during transportation, address the firm which carried out the delivery; if the product functions incorrectly, address the dealer at once.

ATTENTION!

Do not switch on the speaker system immediately after you bring it into a room from environment with negative temperature! After unpacking, the speaker system should be kept in conditions of room temperature for at least 4 hours.

CONTENTS

1. DESCRIPTION	2
2. SAFETY PRECAUTIONS	2
3. PACKAGE CONTENTS	2
4. SPECIAL FEATURES	3
5. SPEAKER SYSTEM PLACEMENT	3
6. CONTROL PANEL	4
7. ACTIVE SPEAKER REAR PANEL	4
8. REMOTE CONTROL	5
9. CONNECTION	6
10. OPERATION	7
11. TROUBLE SHOOTING	12
12. TECHNICAL SPECIFICATION	13

Technical support is on www.sven.fi

1. DESCRIPTION

GRAND active two-way Hi-Fi multimedia speaker system (MSS) with digital control and FM tuner is made of superior materials with implementation of advanced technologies. The MSS is designed to play music, sound games, movies, Karaoke, etc. The device is equipped with a high-power bridge amplifier. Except for two stereo inputs, it has a high quality USB DAC for audio signal transmission via a USB cable. The built-in FM tuner with RDS facility is assembled on the basis of Silicon Laboratories latest developments. The MSS is also equipped with Karaoke module with digital control and two microphone jacks with microphone volume and reverberation level control. A separate headphone amplifier allows to reproduce full sound range. A full-function remote control is included.

2. SAFETY PRECAUTIONS

- To avoid electric shock do not open the MSS and do not perform repairs by yourself.
- Do not allow circuit of wires (including grounded ones) between speakers, power amplifier or ground, for it causes damage of power amplifier output stage.
- Do not put foreign objects inside the holes of the MSS. Make sure that needles, hair pins, coins, insects etc. do not get inside.
- Protect the MSS from high humidity, water and dust. Do not locate it in areas with high level of humidity and dust.
- Protect the MSS from heating: do not locate it near a heat source or expose to direct sunlight.
- Do not use gasoline, alcohol or other solvents when cleaning, since they may damage the paint-coated surface of the MSS. Clean it with dry soft cloth only.
- If the MSS does not operate, unplug it and address your dealer.



Caution! High voltage inside! To avoid the risk of electric shock do not open or touch elements inside.

3. PACKAGE CONTENTS

- Active speaker — 1 pc
- Passive speaker — 1 pc
- Acoustic cable — 1 pc
- 2RCA to 2RCA signal cable — 1 pc
- USB cable — 1 pc
- Power cable — 1 pc
- FM antenna — 1 pc
- Remote control — 1 pc
- CR 2032 Battery — 1 pc
- Rubber feet with self-adhesive base — 8 pcs
- Operation manual — 1 pc
- Warranty card — 1 pc

4. SPECIAL FEATURES

- Active two-way Hi-Fi stereo system with digital control
- Built-in two-channel Hi-Fi power amplifier
- Two CD and PC stereo inputs, USB input, headphone jack, two microphone jacks
- High quality silk tweeters and kevlar woofers
- Two-line 16-character LCD display
- Karaoke module with digital control
- Built-in FM tuner with RDS facility
- Full function remote control
- Active equalizer with timbre control within ± 12 dB
- Master volume control and timbre control
- Headphone and microphone volume control
- Reverberation level control
- High quality USB DAC for high fidelity sound transmission via a USB cable when connected to PC
- High quality headphone amplifier
- Built-in high quality surge protector
- MDF case of speakers

5. SPEAKER SYSTEM PLACEMENT

• Installation of GRAND speaker system graded as Hi-Fi (High Fidelity) class system is one of the most important factors in achieving the best sound of the system. One should know that location of speakers affects tonal balance, intensity and quality of bass components, soundstage depth and width, midrange sounds transparency. On the one hand, the closer the speakers are placed to walls and corners, the more powerful the sound of the bass components is. On the other hand, the farther the speakers are located from walls, the better the soundstage depth is rendered. Angular position and height of speakers' location in relation to the listener affect the timbral balance formation (especially, treble), soundstage width, and acoustic image focusing. Therefore speakers are best located along the shorter wall of the room. The listener and the speakers should be located in the corners of an isosceles triangle as shown in the scheme, Fig.1 where optimal ① and partial ② stereo effect zones are shaded. Angular position and height of the speakers' location in relation to the listener should be defined by experiment. The axes of the speakers should not intersect within the area where the listeners are located.

IMPORTANT! Before placing the speakers, don't forget to attach the 4 rubber feet (included) to the bottom of each speaker.

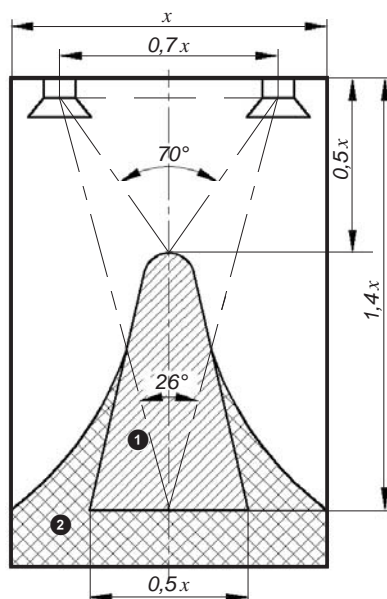

Fig. 1. MSS location scheme

6. CONTROL PANEL

- ① Display screen
- ② IR receiver
- ③ INPUT: audio source selection button
- ④ UP: volume level up button, radio station switch button (in Tuner mode)
- ⑤ PHONES: headphone jack
- ⑥ MODE: mode selection button
- ⑦ DOWN: volume level down button, radio station switch button (in Tuner mode)

7. ACTIVE SPEAKER REAR PANEL

- ⑧ mic 1: 1st microphone connection jack
- ⑨ mic 2: 2nd microphone connection jack
- ⑩ USB: USB input for connecting PC
- ⑪ CD: audio source connection inputs
- ⑫ PC: PC connection inputs
- ⑬ FM antenna: FM antenna connection input
- ⑭ POWER ON/OFF: power switch
- ⑮ Power cable input
- ⑯ speaker out: passive speaker inputs
- ⑰ Phase inverter

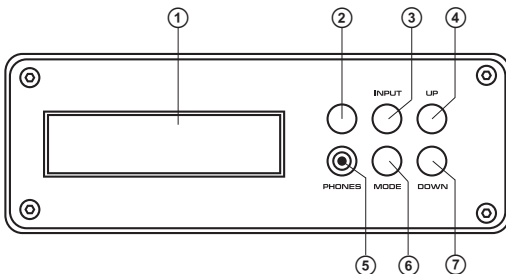

Fig. 2. Active speaker control panel

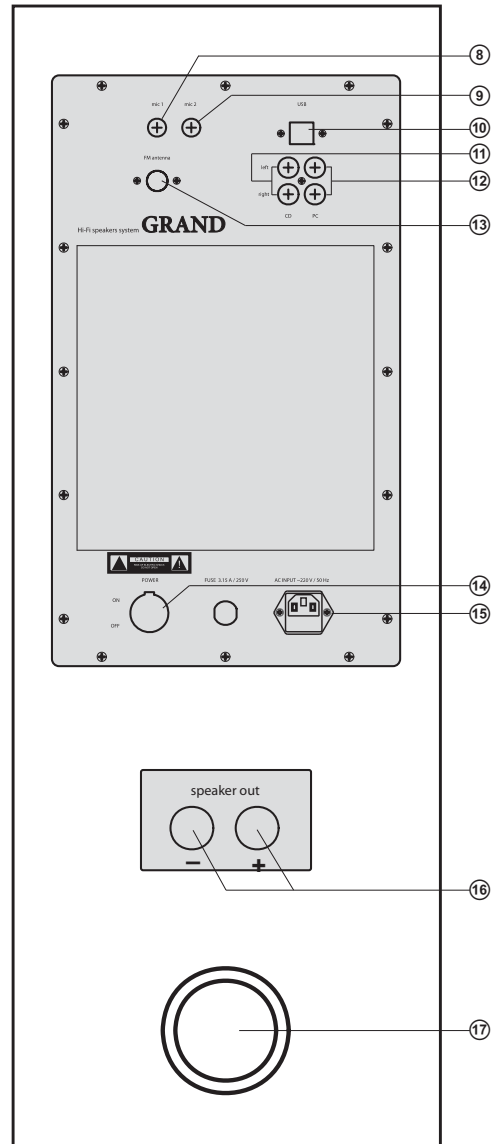

Fig. 3. Active speaker rear panel

8. REMOTE CONTROL

- ① STANDBY: standby mode button
- ② 0-9: numeric keyboard buttons for selecting preset radio stations
- ③ ST: MONO/STEREO mode selection button
- ④ MEM: button for presetting radio stations in the memory of the tuner
- ⑤ INPUT: audio source selection button
- ⑥ MODE +/-: buttons for setting parameters (balance, treble and bass, headphone volume) in various modes
- ⑦ MIC+/-: microphones volume control buttons
- ⑧ +/-: headphone volume control buttons
- ⑨ REVERB+/-: reverb level control buttons
- ⑩ MUTE: mute mode button
- ⑪ +10: multiple factor button for selecting preset radio stations numbered 10 and up
- ⑫ TUNING«+/-»: radio frequency manual setting buttons
- ⑬ PRESET AUTO: auto setting button
- ⑭ CH+/-: preset stations successive selection buttons
- ⑮ VOL+/-: master volume control buttons

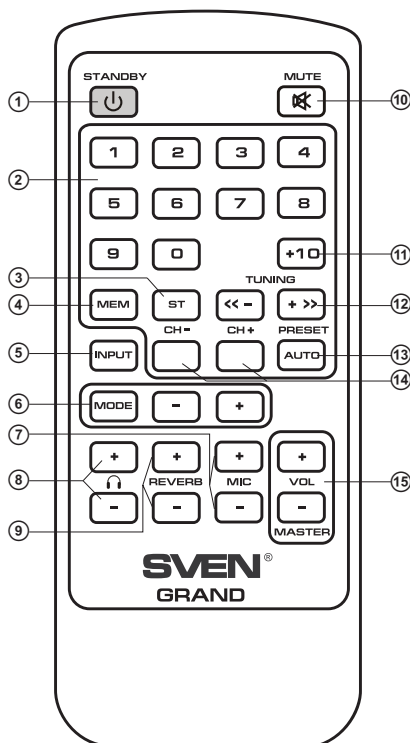

Fig. 4. Remote control

Remote control battery installation

- Open the battery compartment at the back of the remote control.
- Put in the CR2025 battery (included).
- Close the battery compartment.

Notes:

- **Before the first switch-on of the device remove the protective film from the remote control battery compartment.**
- **Use the remote control at an angle not more than 30° at a distance not more than 5 meters.**
- **Direct the remote control at the IR receiver display on the active speaker.**
- **If the remote control does not work, check the battery or replace the discharged battery with a new one.**
- **Remove the battery from the remote control, if you aren't going to use it for a long time (more than a week).**

9. CONNECTION

MSS Connection

GRAND Hi-Fi MSS 2.0 can be connected to virtually any audio source (see Fig. 5).

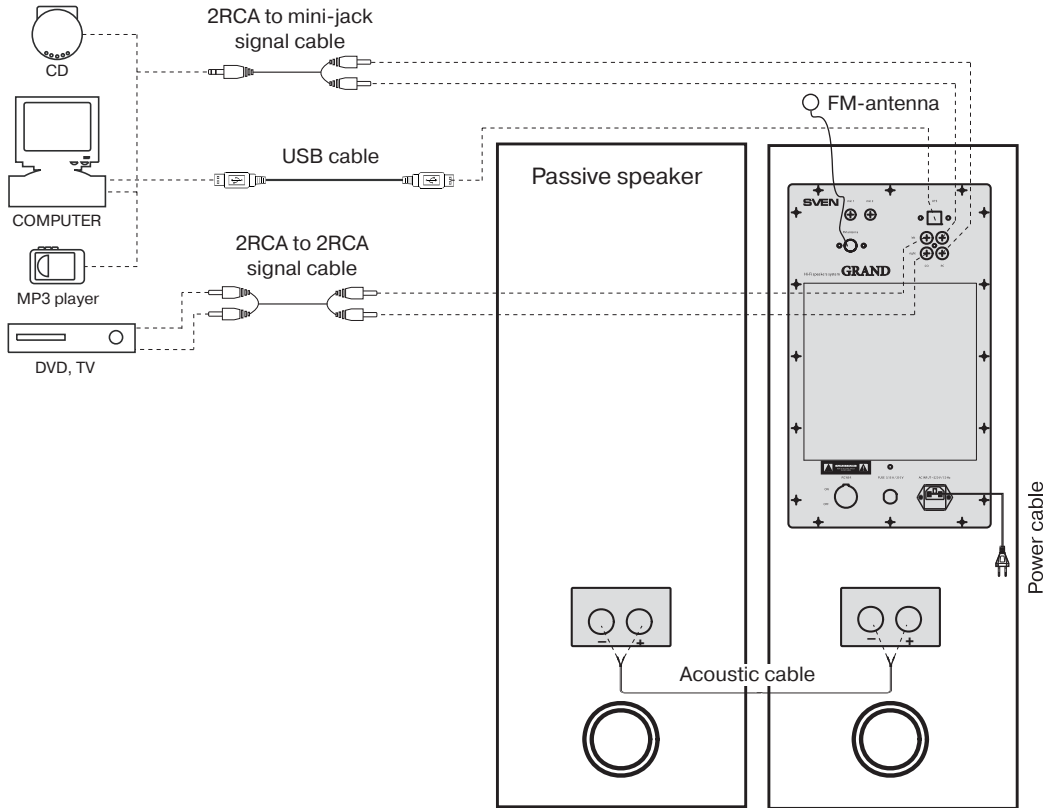

Fig. 5. Connection diagram

- Before connecting, make sure that the MSS is unplugged. Then connect the active speaker to the passive speaker via the acoustic cable (included). Mind that the positive (red) terminals of the active speaker must be connected to the red terminals of the passive speaker (+ → +), and the negative (black) terminals of the active speaker must be connected to the black terminals of the passive speaker (- → -).
- To connect the speaker system to a TV, DVD/VCD/VHS-player, connect the RCA-jacks of the 2RCA to 2RCA signal cable (included) to the CD R/L inputs ⑩ of the active speaker, and then to the TV or DVD/VCD/VHS-player outputs, as shown in Fig.5.

- To connect the MSS to a PC or an MP3/CD-player, first insert the RCA-jacks of the 2RCA to Ø 3.5 mm mini-jack signal cable (included) into the PC input ⑫ of the active speaker, and then insert the mini-jack of the signal cable into the LINE OUT port of the PC sound card or into the MP3/CD-player output (see Fig. 5).
- To connect the MSS to a USB port of your PC or laptop, use the USB cable included in the package contents. In order to do this, attach the USB cable connector to the USB input ⑩ on the rear panel of the active speaker, and insert the other connector of the USB cable to an available USB port of your PC or laptop. The MSS has a built-in high quality USB DAC providing clear sound transmission via a USB cable.

Notes:

- **Make sure that the cables are reliably fixed in the terminals, the polarity is observed and bare cables are not in contact with each other and the metal parts of equipment. Mind the correct connection of all the channels and reliable fixation of the connecting cables in the jacks, otherwise considerable noises in sound reproduction may occur.**
- **Sound quality is directly affected by correctness and reliability of the connection of cables. The left RCA jack must be inserted into the left (white) input of the amplifier and the right one into the right (red) input of the amplifier. It is recommended to use cables that are included in the package contents of the MSS.**

FM antenna installation and connection

- Insert the included room FM antenna into the FM antenna input ⑬ on the rear panel of the active speaker, as shown in the diagram, Fig. 5. Install the FM antenna in such a way that reception quality is satisfactory, and then fix the antenna in this position.

Note. *An external 75 Ohm FM antenna should be used for buildings with weak FM signal. Typically, a three-element antenna is enough, but for areas with weak FM signal it is required to use an FM antenna with 5 or more elements.*

10. OPERATION**Switching On**

- To switch on the MSS, insert the power cable into the input ⑮ and then insert the power cable plug into the mains socket. Shift the POWER On/ Off switch (⑭, ON position) on the rear panel of the active speaker into ON position. Then press STANDBY button ① on the remote control to switch on the system. The display screen ① on the front panel of the active speaker will illuminate.

Audio Source Selection

- To select an audio source, press INPUT button ⑤ on the remote control or INPUT button ③ on the control panel. When the INPUT button is pressed, the LCD display on the active speaker front panel will successively show names of inputs: CD (see Fig. 6), PC (Fig. 7), USB (Fig. 8), referring to the connected audio source, or FM station (see Fig. 9).

IMPORTANT! *If the MSS is connected via a USB port, the computer must find this connection and install (if necessary) corresponding drivers. Drivers are not required for Windows XP/Vista/7.*

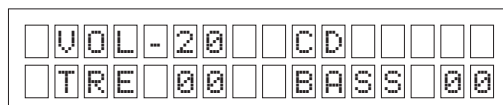

Fig. 6. CD input

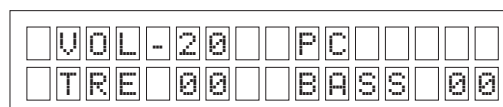

Fig. 7. PC input

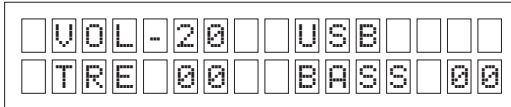

Fig. 8. USB input

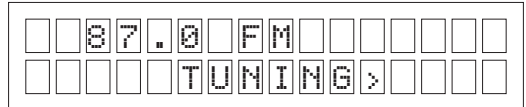

Fig. 9. FM input

MSS setting with audio sources connected

- Master volume can be adjusted with VOL+ and VOL- buttons ⑮ of the remote control. Volume increasing/reducing will be shown on the LCD display (Fig. 10), the VOL inscription will flash for 5 seconds. Within this time you can set the desired volume level. The volume level ranges from -99 (minimum, the sound can't be heard) to 00 (maximum).

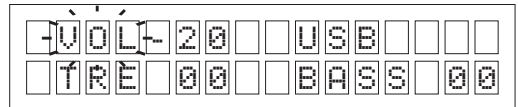

Fig. 10

- Balance level between the right and left speaker, treble level, bass level, headphone volume level can be adjusted with MODE button ⑥ on the remote control or MODE button ⑥ on the active speaker control panel. If you press the MODE button once, adjustment of balance between the left and right speaker will switch on, and LEFT or RIGHT inscription will flash on the LCD display. Using MODE- and MODE+ buttons of the remote control select the desired balance between the speakers within 5 seconds. The level ranges from -15 to 00. For convenient use of the MSS there is an option of quick balancing of the speakers with CH- and CH+ buttons ⑭ of the remote control without using the MODE button.

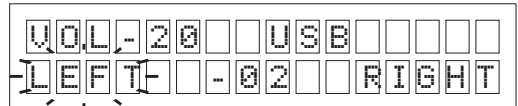

Fig. 11

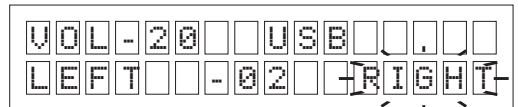

Fig. 12

Note. If you don't make any settings within 5 seconds, the system will return to the initial position.

- If the MODE button is pressed twice, the treble level adjustment mode will switch on, and TRE inscription will flash on the LCD display (Fig.13). Using MODE- and MODE+ buttons select the desired treble level within 5 seconds. The level ranges from +14 to -14.

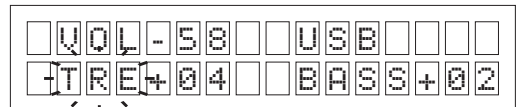

Fig. 13

- If the MODE button is pressed three times, the bass level adjustment mode will switch on, and BASS inscription will flash on the LCD display (Fig. 14). Using MODE- and MODE+ buttons select the desired bass level within 5 seconds. The level ranges from +14 to -14.

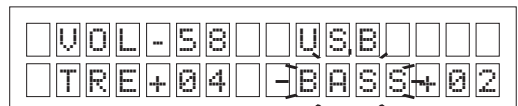

Fig. 14

- If the MODE button is pressed four times, the headphone volume level adjustment mode will switch on, and HEADPHONE inscription will flash on the LCD display (Fig. 15). Using MODE- and MODE+ buttons ⑥ select the desired headphone volume level within 5 seconds. The level ranges from +14 to -14. For convenient use of the MSS there is an option of quick headphone volume level adjustment with buttons \hat{H} +/- ⑧ of the remote control without using the MODE button.

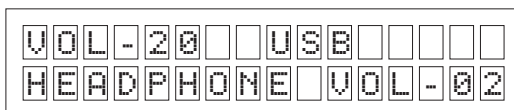

Fig. 15

The level ranges from +14 to -14. For convenient use of the MSS there is an option of quick headphone volume level adjustment with buttons \hat{H} +/- ⑧ of the remote control without using the MODE button.

ATTENTION!

- **All the MSS settings and adjustments listed above can be made with control panel buttons if the remote control does not operate for some reason. An audio source can be selected by successive pressing of INPUT button ③ of the control panel. The left and right speaker volume balance, treble and bass level, as well as headphone volume level, is adjusted with MODE button ⑥, UP ④ and DOWN ⑦ buttons on the control panel. The sequence of actions is the same as for adjustment with the remote control. The LCD display will show all the settings and adjustments made, as shown in the figures above.**

- **When using FM mode, press the MODE button until TUNING inscription appears on the LCD display (see Fig. 16), then using UP and DOWN buttons search FM stations on the control panel.**

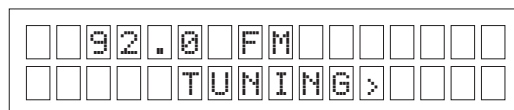

Fig. 16

FM-tuner settings

- GRAND multimedia speaker system has a built-in FM tuner with RDS facility. RDS function allows to receive and display additional information transmitted simultaneously with the radio station signal, for example, HIT FM (Fig. 17), or no RDS, if the signal of the radio station does not contain any additional information (see Fig. 18).

- To switch on the FM-tuner, select the FM-mode by successively pressing INPUT button ⑤ on the remote control or INPUT button ③ on the control panel. The inscription shown in Fig. 16 will appear on the LCD display. The system can be tuned automatically or manually.

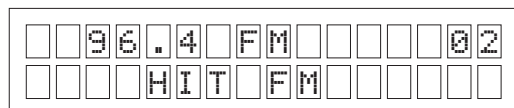

Fig. 17

- To switch on the FM-tuner, select the FM-mode by successively pressing INPUT button ⑤ on the remote control or INPUT button ③ on the control panel. The inscription shown in Fig. 16 will appear on the LCD display. The system can be tuned automatically or manually.

Autotuning. When the AUTO mode is on, radio stations are automatically searched and successively recorded in the memory of the device. All the available FM-range (87 MHz – 108 MHz) is scanned and all the radio stations are recorded into the memory (up to 40). To switch on auto search, press AUTO button ③ on the remote control. AUTO PRESET inscription (Fig. 19) will appear on the LCD display. After scanning, the first preset station will switch on. To change the station, press the preset stations successive selection button CH +/- ⑭ on the remote control or UP ④ and DOWN ⑦ buttons on the control panel.

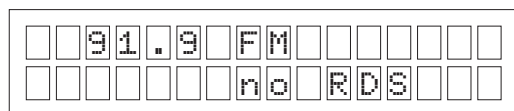

Fig. 18

Manual tuning. You can search radio stations manually by successively pressing TUNING -/+ buttons ⑫ on the remote control. Short (less than 0.5 sec) pressing of the button allows to adjust the frequency to 0.1 MHz. If the button is pressed longer (more than 0.5 sec) the scanning continues up to the next station. Scanning the stations up (+) and down (-) you find the necessary one. When a new station is found, the information about it will show on the LCD display.

Presetting (programming) of stations.

During manual search, stations can be preset, assigned new numbers and recorded into the memory of the device. Press MEM button ④ on the remote control, and MEMORY inscription will appear on the LCD display (see Fig. 20).

Next, assign this station a two-digit number within 00 – 39, then using the numeric keyboard buttons ② and ⑪ of the remote control enter this number into the memory of the device and press MEM button again. For example, 93,8 FM station was assigned 00 number. This number will display in the right upper corner of the LCD-display (Fig. 21). After programming of the stations, to switch on the FM tuner, enter the number of the desired station using the numeric keyboard buttons ② and ⑪ of the remote control. The tuner will switch on at this station's frequency. An inscription will appear on the LCD display, as shown in Fig. 22, where 99,4 is the frequency, ALLA is the name of the station, and 12 is the preset number of the station.

Important! To switch on the station numbered 2, press button 2 on the numeric keyboard; to switch on station 10, press +10 button ⑪ on the remote control once. If you want to switch on station 20, press +10 button twice, for station 30 press +10 button three times. If you need station 14, first press +10 button, then button 4 on the numeric keyboard, and you'll see the station frequency, number and name on the LCD display (Fig. 23).

Note. If you want to skip an undesired station while manually scanning the FM-range, press the TUNING -/+ button ⑫ on the remote control and hold it for more than 0,5 sec. To delete an undesired station from the memory of the device reprogram its number by assigning it to another found station.

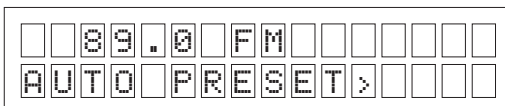

Fig. 19

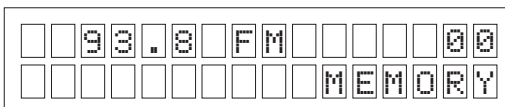

Fig. 20

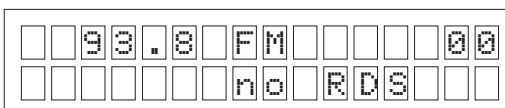

Fig. 21

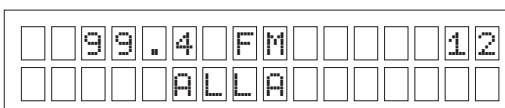

Fig. 22

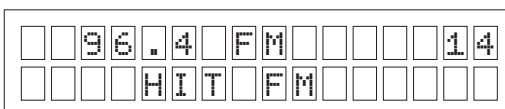

Fig. 23

Headphone usage. GRAND active two-way Hi-Fi stereo system has a built-in high quality headphone amplifier, which allows to enjoy music from a player or tuner without distracting others' attention. In order to switch on the headphones, connect them to the PHONES input ⑤ on the active speaker front panel. Then, using INPUT button ⑤ of the remote control or INPUT button ③ on the control panel, find an audio source you're going to listen to the music from, for example, USB. If you press MODE button of the remote control four times, the headphone volume level adjustment mode will switch on, and the HEADPHONE inscription will flash on the LCD display for 5 seconds (Fig. 24). During this time select the desired headphone volume level using MODE +/- buttons ⑥. For convenience there is an option of quick headphone volume level adjustment with \curvearrowright +/- buttons ⑧ of the remote control without using the MODE button. You can see the information about the headphone volume level in the right upper corner of the second line on the LCD display: as in the previous example, it was VOL-02 (see Fig. 24), and became VOL-12 (Fig. 25).

Note. To reduce master volume use VOL- button ⑮ of the remote control. To switch off the sound press MUTE button ⑩ of the remote control.

Microphone usage

- GRAND active two-way Hi-Fi MSS has two jacks for connecting microphones on the active speaker rear panel – mic 1 ⑥ and mic 2 ⑦, which makes it possible to use the connected microphones when playing Karaoke sound-tracks.

- To switch on the microphones, connect them to the above mentioned mic 1 and mic 2 jacks. You can connect one microphone or both microphones simultaneously. Then make presetting. Using INPUT button ⑤ of the remote control or INPUT button ③ on the active speaker control panel, select an audio source you want to lay the voice over. Then using VOL+/- ⑮ and MIC-/ + ⑦ buttons on the remote control adjust the audio source volume and microphone (or both microphones) volume to the same level. These adjustments will be shown on the LCD display (Fig. 26 and 27).

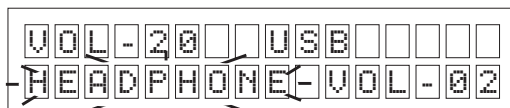

Fig. 24

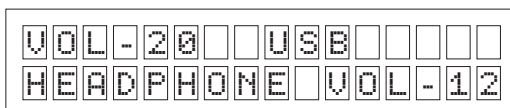

Fig. 25

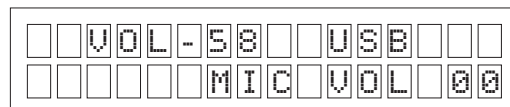

Fig. 26

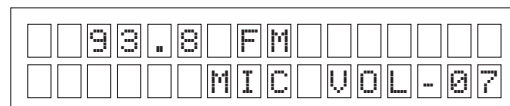

Fig. 27

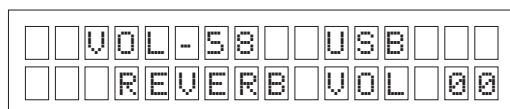

Fig. 28

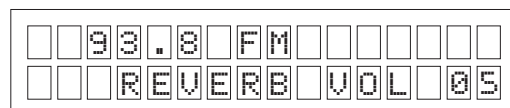

Fig. 29

- To give the sound of the voice a desirable colouring, switch on reverberation mode. Using REVERB-/+ buttons ⑨ on the remote control, adjust the desired reverberation level. The LCD display will show the following: if it is a USB input, you'll see an inscription like in Fig. 28, and if it is an FM station, you'll see an inscription like in Fig. 29.

STANDBY mode

- STANDBY function is designed to quickly switch on/off the device and economize power consumption. Press STANDBY button ① of the remote control to turn on this function. If the STANDBY mode is on, the MSS enters Sleep mode. Press STANDBY button again, and the device will return to operation mode.

MUTE mode

- To turn off the sound press MUTE button ⑩ on the remote control. To switch on the sound press MUTE button ⑩ again.

Notes. *Sound quality is directly affected by correctness and reliability of the connection of cables. It is recommended to use cables that are included in the package contents of the MSS. Usually, the right channel is marked in red, and the left channel is marked in white.*

11. TROUBLE SHOOTING

Problem	Cause	Solution
The MSS does not turn on.	The MSS isn't connected to a mains outlet.	Check the connection.
	Power switch is off.	Turn on the switch.
No sound or there is too quiet sound of speakers.	Volume level is set at minimum value.	Adjust the volume control knob.
	The audio source is improperly connected.	Connect audio sources correctly.
Distortion of sound.	Large amplitude of the input signal.	Turn down the source volume and MSS volume.
The remote control is not working.	The battery is discharged.	Replace the battery with a new one.
	There is direct sunlight.	Change location of subwoofer or remote control.
	Obstacle between the remote control and the receiver on the control panel.	Change the speaker or remote control location.
The FM tuner is not working.	The FM tuner is not connected.	Connect the FM antenna.
	Poor reception of antennas.	Connect an external FM antenna.

If none of the above methods can solve the problem, please seek professional advice at your nearest service center. Never attempt to repair the product yourself.

12. TECHNICAL SPECIFICATION

Parameter, measurement unit	Value
Speaker System	
Output power (RMS), W	240 (2 × 120)
Frequency response, Hz	32 – 20 000
S/N ratio, dB	≥ 90
Tweeter size, mm	∅ 38
Woofer size, mm	2 × ∅ 203
Voltage supply, V/Hz	~220/50
Dimensions (one speaker) (W × H × D), mm	240 × 1300 × 300
Weight (active + passive speaker), kg	29.5 + 23.5
FM Tuner	
Frequency range, MHz	87 ~ 108
Tuner sensitivity, dB	≤ 20
S/N ratio, dB	≥ 45

Notes:

- **Technical specification given in this table is supplemental information and cannot give occasion to claims.**
- **Technical specification is subject to change without notice due to improvement of SVEN production.**

Active Two-way Hi-Fi Stereo System with Digital Control

SVEN®
YOU WANT – WE CAN



Модель: **GRAND**

Импортер в России: ООО «СКАНДИТРЕЛ»,
111024, РФ, г. Москва, ул. Авиамоторная, д. 65, стр. 1.
Уполномоченная организация в России: ООО «РТ-Ф»,
105082, г. Москва, ул. Фридриха Энгельса, д. 75, стр. 5.
Условия гарантийного обслуживания смотрите в
гарантийном талоне или на сайте **www.sven.fi**
Гарантийный срок: 12 мес.
Срок службы: 5 лет.
Произведено под контролем «Свен Скандинавия
Лимитед», 48310, Финляндия, Котка,
Котлахдентие, 15. Сделано в Китае.

Модель: **GRAND**

Постачальник/імпортер в Україні: ТОВ «СВЕН Центр».
Київська область, м. Переяслав-Хмельницький,
вул. Героїв Дніпра, 31.
Призначення, споживчі властивості та відомості
про безпеку товару див. у керівництві з експлуатації.
Умови гарантійного обслуговування дивіться в
гарантійному талоні або на сайті **www.sven.fi**
Гарантійний термін: 12 міс.
Строк служби: 5 років.
Товар сертифіковано/має гігієнічний висновок.
Шкідливих речовин не містить.
Зберігати в сухому місці.
Виготовлено під контролем «Свен Скандинавія
Лімітед», 48310, Финляндия, Котка, Котлахдентіє, 15.
Зроблено в Китаї.

Produced under the control of Oy Sven Scandinavia Ltd.
15, Kotolahdentie, KOTKA, Finland, 48310.
Made in China.

® Registered Trademark of Oy SVEN
Scandinavia Ltd. Finland.

GRAND